

WALLE12 BCD

SPECIAL APPLICATION PROFILE
PROFIL SPECJALNY

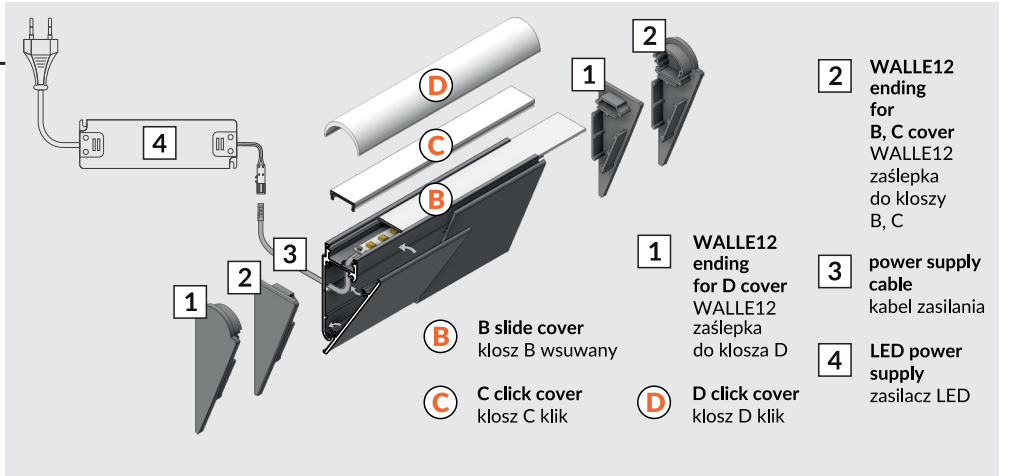
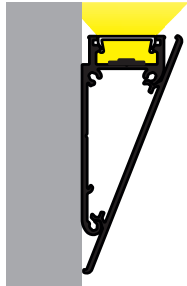
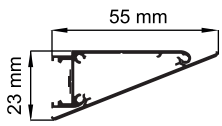

2 WALLE12 ending for B, C cover WALLE12 zaślepka do kloszy B, C

3 power supply cable kabel zasilania

4 LED power supply zasilacz LED

1 WALLE12 ending for D cover WALLE12 zaślepka do klosza D

B B slide cover klosz B wsuwany

C C click cover klosz C klik

D D click cover klosz D klik



scissors nożyczki



pliers kombinerki



soldering iron lutownica



solder cyna



glue klej

I

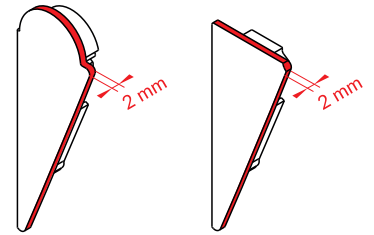
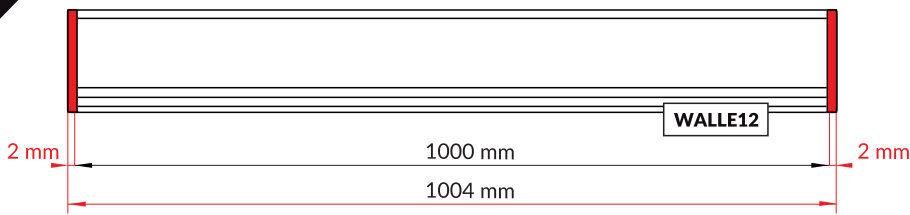

Note! Ending thickness increases the length of the luminaires (+ 2 x 2 mm).
Uwaga! Grubość zaślepki zwiększa długość oprawy (+ 2 x 2 mm).

II

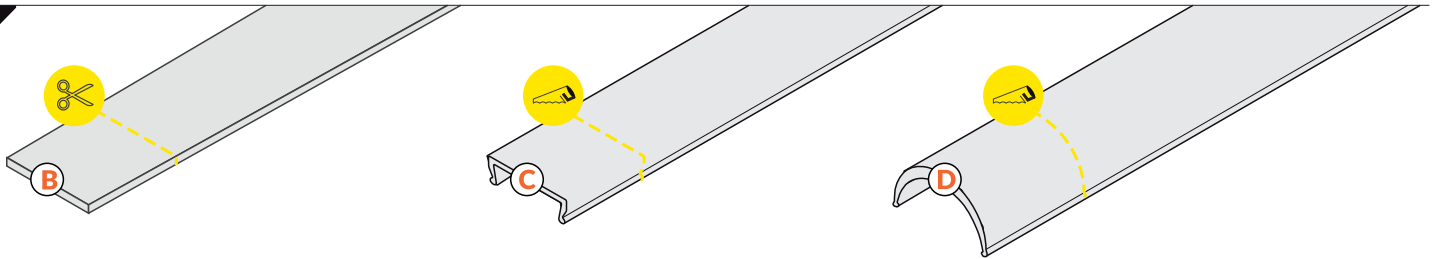

The length of the cover is equal to the length of the profile.
Długość klosza równa jest długości profilu.

III

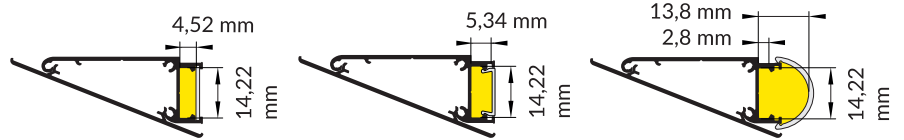
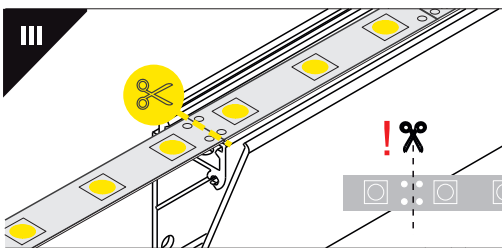

Dimensions of the space to install LED source. / Wymiary przestrzeni do zamontowania źródła LED.

IV

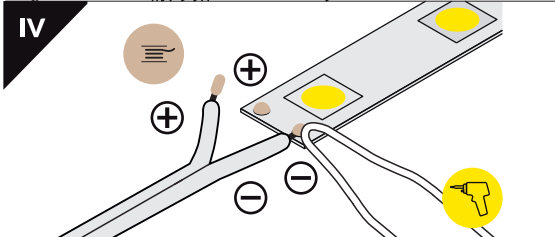

V

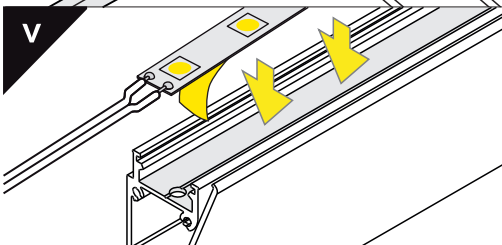

VI

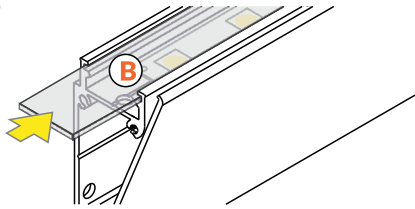

B slide cover / klosz B wsuwany

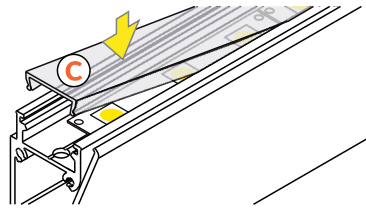

C click cover / klosz C klik

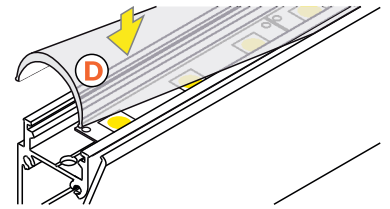

D click cover / klosz D klik

VII MOUNTING / MONTAŻ

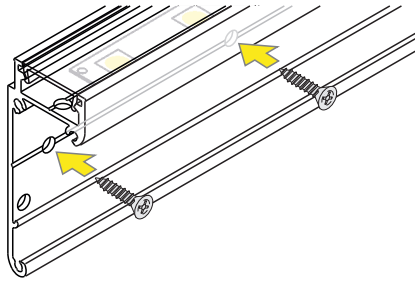
screw
wkreć

MOUNTING / MONTAŻ

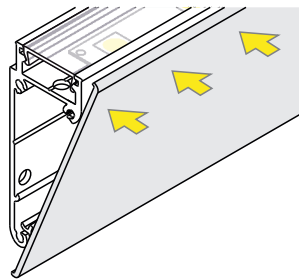
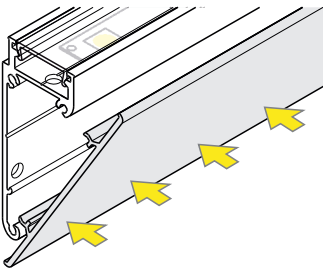

MOUNTING / DEMONTAŻ

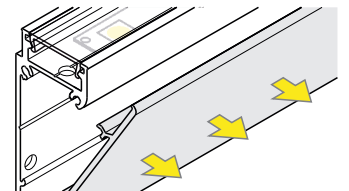
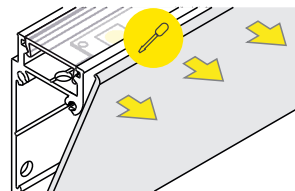
**NOTE! / UWAGA!****Do not pull the cover by force. A flat tool should be used to remove the cover.**

Nie wrywać osłony na siłę.

W celu zdemontowania osłony należy podważyć ją płaskim narzędziem.

VIII CONNECTORS / ŁĄCZNIKI

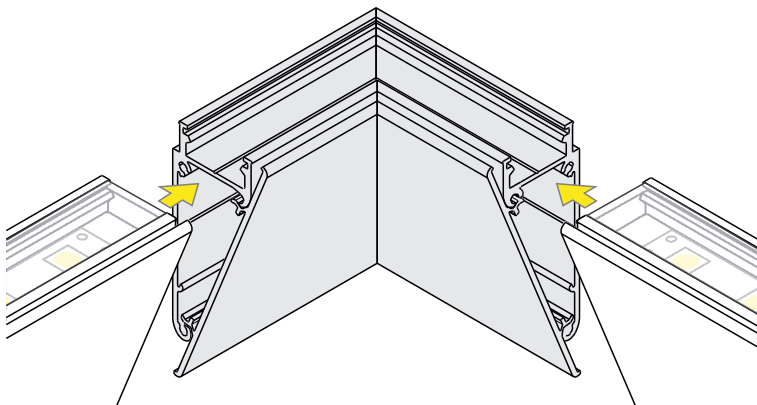
WALLE12 L connector
WALLE12 łącznik LWALLE12 X connector
WALLE12 łącznik kątowy X

IX POWER SUPPLY / ZASILANIE

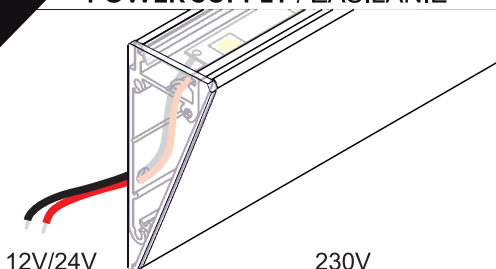

12V/24V

230V

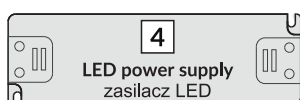
LED power supply
zasilacz LED

ACCESSORIES / AKCESORIA

- power switches
- controller + remote
- movement sensors
-
- włączniki
- sterownik + pilot
- czujniki ruchu

WIRELI
www.wireli.cz